

KAVO

ESTETICA

E70 / E80 Vision
The masterpiece.



KAVO
Dental Excellence

KaVo – The dental unit.
An investment in your health.



KaVo dental units are your dependable practice partners. KaVo dental units are unrivalled when it comes to promoting a natural posture with exceptional freedom of movement and short reach distances. They provide the ideal ergonomic solution for every conceivable treatment situation. We aim to combine the highest standards of hygiene with an aesthetic design to create a feel-good atmosphere for users and patients alike. This perfectly harmonised package for the dental workplace includes a long service life and total reliability – Made in Germany.



ERGONOMICS

The ultimate in comfort for dentists and patients alike. The wellbeing and long-term health of your practice team is our top priority.



USER EXPERIENCE

Ingenious functionality meets smart customisation – a winning combination for efficient, successful dental practices.



HYGIENE

Greater safety in every process – discover what comprehensive hygiene looks like with KaVo. Experience our fully automatic processes and smart, intuitive hygiene solutions for yourself.



QUALITY

Proven trustworthiness Made in Germany – KaVo has been offering the ultimate in quality for over 100 years. We use only high-quality, robust components and check all products for strict compliance with the most exacting international and internal quality standards. For added durability, stability and reliability.



ERGONOMICS



USER EXPERIENCE



HYGIENE



QUALITY

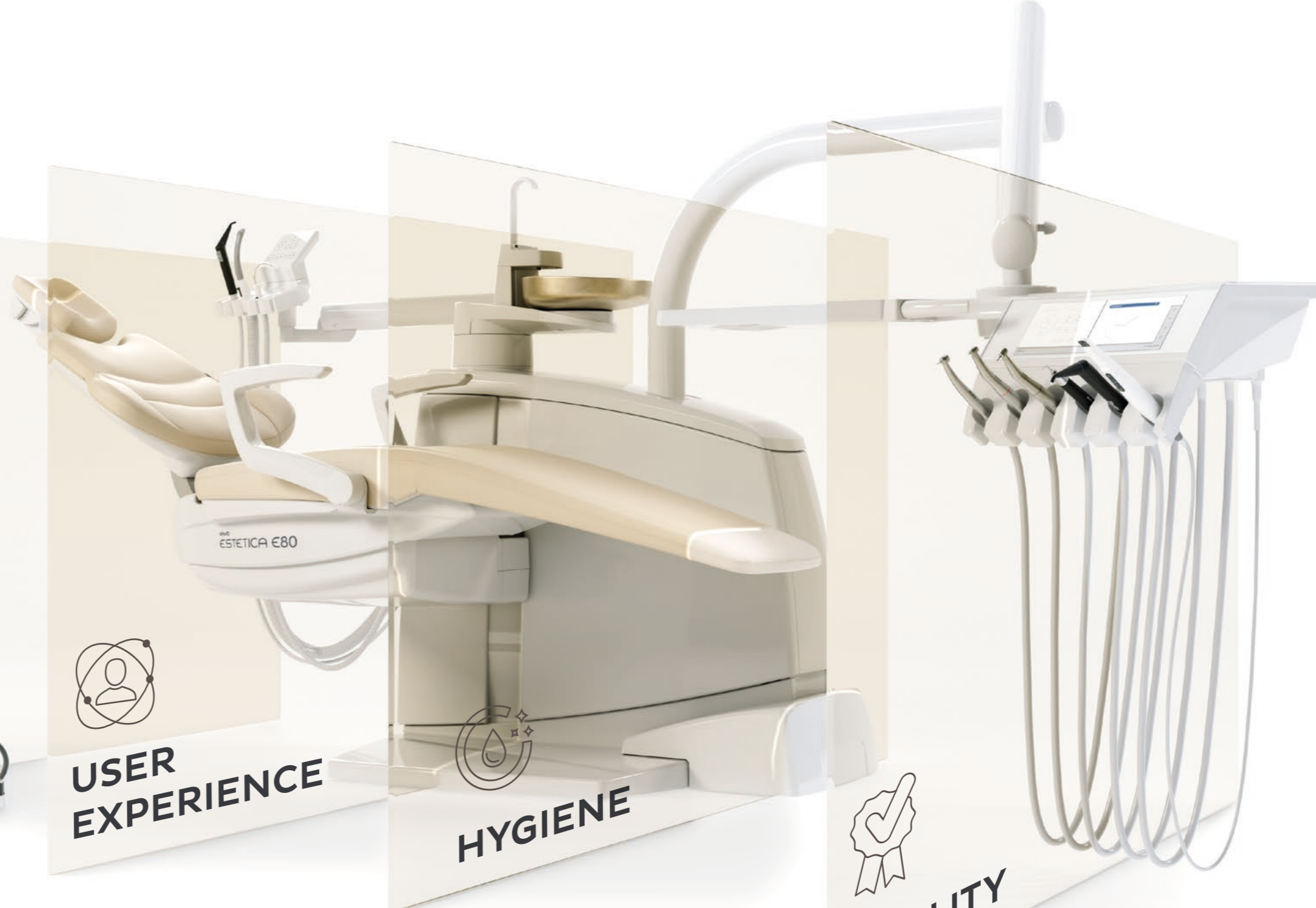

Superlative working comfort

- AGR-certified suspended chair concept with horizontal tracking promotes healthy posture
- Supreme comfort for practitioners and patients with premium components from KaVo
- A relaxing atmosphere: indirect lighting and SPALight.
- Fully height adjustable for maximum versatility
- Lightweight, multifunctional and ideal for relaxed working: the ergonomic KaVo foot control
- See more with the new KaVo Lumina treatment light

Cutting-edge technology, intuitive handling and maximum efficiency for a premium practice experience

- Responsive, intuitive, quick and easy to use: high-resolution 7" and 12" touch display
- Efficient working: rapid access to all functions optimises your daily work.
- Central control: quick and easy operation of patient chair, hygiene and treatment light functions for dentists and assistants.
- Straightforward patient communication at the unit for trust and transparency.

A feel-good experience before, during and after treatment

- Maximum treatment safety and reliability: KaVo DVGW water block – the undisputed pioneer
- Fully automated hygiene centre takes care of water-bearing lines and suction systems
- Expert guidance with easy step-by-step instructions
- Unique suction germ reduction with gel ensures impressive performance for suction hoses

Designed, developed and manufactured in Germany

- Extremely sturdy: solid base formed of 318 kg metal
- High-quality plastics: certified for exacting requirements in everyday practice
- Low-maintenance and easy to service: cutting-edge technology meets tried-and-tested electronic components
- Reliable even under heavy loads: tested for a service life of over 10 years and at loads of 700 kg
- Rapid professional assistance: expert service in person and via the hotline



Premium, only better –
the genesis of a masterpiece.

With their premium holistic concept, the ESTETICA E70 and E80 Vision models are outstanding dental units from KaVo. They offer superior comfort, award-winning design and, thanks to their suspended chair concept, the perfect balance between ergonomic working and precise, efficient workflows.

Highlights at a glance

The dentist element. A brilliant display.

- Next-generation touch display with brilliant resolution and impressively rapid response time
 - T-table with 12" widescreen
 - Cart with 7" horizontal display
 - E70: S-table with 7" vertical display
- Practical, personalisable widgets
- Intuitive operating concept for rapid direct access to all key functions for smooth, efficient treatment processes
- Integrated endodontic function with 3 different modes for file control and an expandable file database with almost 200 preset files
- Integrated surgery function* with small, light-weight surgical motor and integrated saline pump

Treatment chair: certified ergonomics in an award-winning design

- Unique, AGR-certified suspended chair concept provides optimal ergonomic comfort for practitioners and their teams
- Maximum flexibility with the largest travel range on the market
 - Lowest position 350 mm: for small practitioners and large patients
 - Highest position 900 mm: for tall practitioners and working while standing
- Extremely lightweight multifunctional foot control for fatigue-free, ergonomic working while standing or sitting – also available as a wireless version
- Comfortable patient chair with easy access and a permissible patient weight of up to 180 kg

Design highlights for a stylish look

- New "Inspired by Nature" colour collection, comprising 14 shades created to complement current interior design trends
- Wonderfully soft standard upholstery with a matt finish

- RELAXline soft upholstery with a soft, leather-like surface and premium design seams for added comfort in the chair
- Striking lighting element for indirect light and a relaxing spa vibe

Safe hygiene: fully automated and highly efficient

- Integrated hygiene centre for instrument and suction hoses, ensuring time-efficient automated cleaning and germ reduction, plus intuitive instructions.
- Integrated DEKamat and OXYmat for easy, efficient placement of cleaning agents within the dental unit

Patient communication with KaVo CONNECT

- KaVo CONNECTbase for easy patient communication at the dental unit itself – no need to install additional software. Simply on switch the camera, and you're good to go.
- CONNECTlink, the interface between CONNECTbase and the matching imaging or patient management software, enables direct transfer of images into the patient file

New accessories

- Ultra-lightweight KaVo Lumina treatment light with UX Light Technology, delightful SPALight and the new COMPOshape mode
- New KaVo eSCALER for effective tooth cleaning – Made by KaVo
- Integrated precise imaging – the KaVo ProXam iOS intraoral scanner for digital impression taking in record time and the compact KaVo ProXam iX delight practitioners with their precision and ease of use.

*Product not shown



Utterly intuitive and hygienic.
The highly sensitive user
interface of the dentist
element with premium
glass surface

High-resolution ingenuity at your fingertips.

With the highly sensitive, responsive touch display, you can control your KaVo ESTETICA E70/E80 Vision more intuitively and quickly than ever before. The KaVo operating philosophy and the design of the user interface are geared towards efficient workflows and effective

practice procedures. The self-explanatory operating logic and quick access buttons allow you to access all essential functions and information immediately in any treatment situation.

Your dental unit. Your choice.

The equipment of your KaVo ESTETICA E70/E80 Vision can be customised to your personal requirements down to the finest detail. The flexible instrumentation allows you to integrate special devices with ease. The dentist and assistant elements can be fitted out as you and your team require them. Many functions can also be individually set for the specific practitioner, including personalisation with the practitioner's name, treatment types or the buttons on the homescreen.

The KaVo ESTETICA E70/E80 Vision is available in T-table and Cart versions.



Greater freedom. Greater comfort.

Access all the functions and parameters of integrated special devices that you need during treatment quickly and easily using the touch display or foot control. All information is constantly in view on the dentist element. Individual treatment sequences can be freely programmed.

The ESTETICA E70 Vision is also available as a swing-arm version. With the swing table version, you can choose whether you want preset locking positions for perfectly balanced instrument swing arms. A new, additional 70-cm position is now available alongside the short 50-cm pull-out position. The maximum hose pull-out length is 90 cm.

KaVo instruments - feel the difference.



Our instruments are made from the finest materials, developed exclusively for our products. These are paired with our unique product architecture – fabricated from solid workpieces – for extraordinary precision and durability. We set the standard for the dental instruments of today. This wealth of experience, borne of over a century of constant innovation, is reflected in the design and functionality of our current instruments. The result is optimum user performance through precise, fatigue-free working.



Products that meet your expectations

When it comes to your instruments, you want only the best. KaVo instruments cover all areas of application and provide the best possible visibility and access to the oral cavity – so you can always offer treatment of the highest quality and precision. In combination with the lightweight, ultra-compact and smooth-running INTRA LUX KL 703 LED micromotor, you can work efficiently and fatigue-free across the entire speed range from 100 to 40,000 rpm thanks to SMARTdrive.



Specialist technology for everyone.



The new KaVo eSCALER

The new KaVo eSCALER is Made in Germany – Made by KaVo.

The KaVo eSCALER allows for highly precise and time-efficient tooth cleaning: the linear oscillation of the tip is particularly effective, at up to 30,000 Hz. The precisely defined ultrasonic vibration, ergonomically shaped dental handpiece, daylight illumination and delicate tips, which allow users to access even hard-to-reach areas with ease, provide maximum treatment comfort for both the patient and the practitioner.



KaVo SONICflex – the all-round pro for top performance

The KaVo SONICflex is an all-round pro: it can handle almost any indication and provides comfortable, enamel-friendly treatment. With gently pulsating sonic vibration at approx. 6,000 Hz and a choice of over 50 tips, this scaler is popular with patients and practitioners alike and is perfect for all areas of application, including prophylaxis, endodontics, periodontics, minimally invasive caries treatment and preparation.

Tip-top endodontics

With 3 different file control modes, the integrated endodontic functions save you from having to purchase an expensive endodontic device.

The integrated file database with almost 200 preset files allows you to call up, set and save key parameters such as transmission ratio and torque values via the dentist element – and add new files at any time.

The smart surgery option

Make even the most demanding procedures as comfortable as possible by equipping your KaVo ESTETICA E70/E80 Vision with the KaVo INTRA LUX S600 LED. This is one of the lightest and smallest surgical motors.

When used in combination with KaVo surgical instruments and the integrated saline pump, you have all the functions of a modern surgical unit at your disposal.



An important investment in your health.

The unique, award-winning suspended chair concept is the central element of KaVo's premium ergonomics. Three features provide excellent ergonomic conditions: maximum legroom for optimal accessibility to the patient, impressive high and low positions for comfortable working while sitting or standing, and safe and comfortable patient positioning. In recognition of this, the KaVo ESTETICA E70/E80 Vision is the only dental unit to have been awarded the AGR seal of approval for tested ergonomics.



Size is just a question of attitude.

The KaVo ESTETICA E70/E80 Vision can be adjusted to your personal requirements and working practices. And to your height. Whether you're short or tall, the variable height of the patient chair can be set at between 350 mm and 900 mm, ensuring optimal ergonomic comfort, regardless of whether you prefer to perform treatment work sitting or standing.

Highest position: 900 mm;
lowest position: 350 mm



Strength in serenity

The integrated slow motion function moves the patient chair of the E70/E80 Vision at a reduced speed. You'll particularly appreciate this slow mode when using the microscope or treating older patients.



Going strong

There's plenty of comfort for large and heavy patients, too: the ESTETICA E70/E80 Vision is approved for patients with a maximum weight of up to 180 kg.

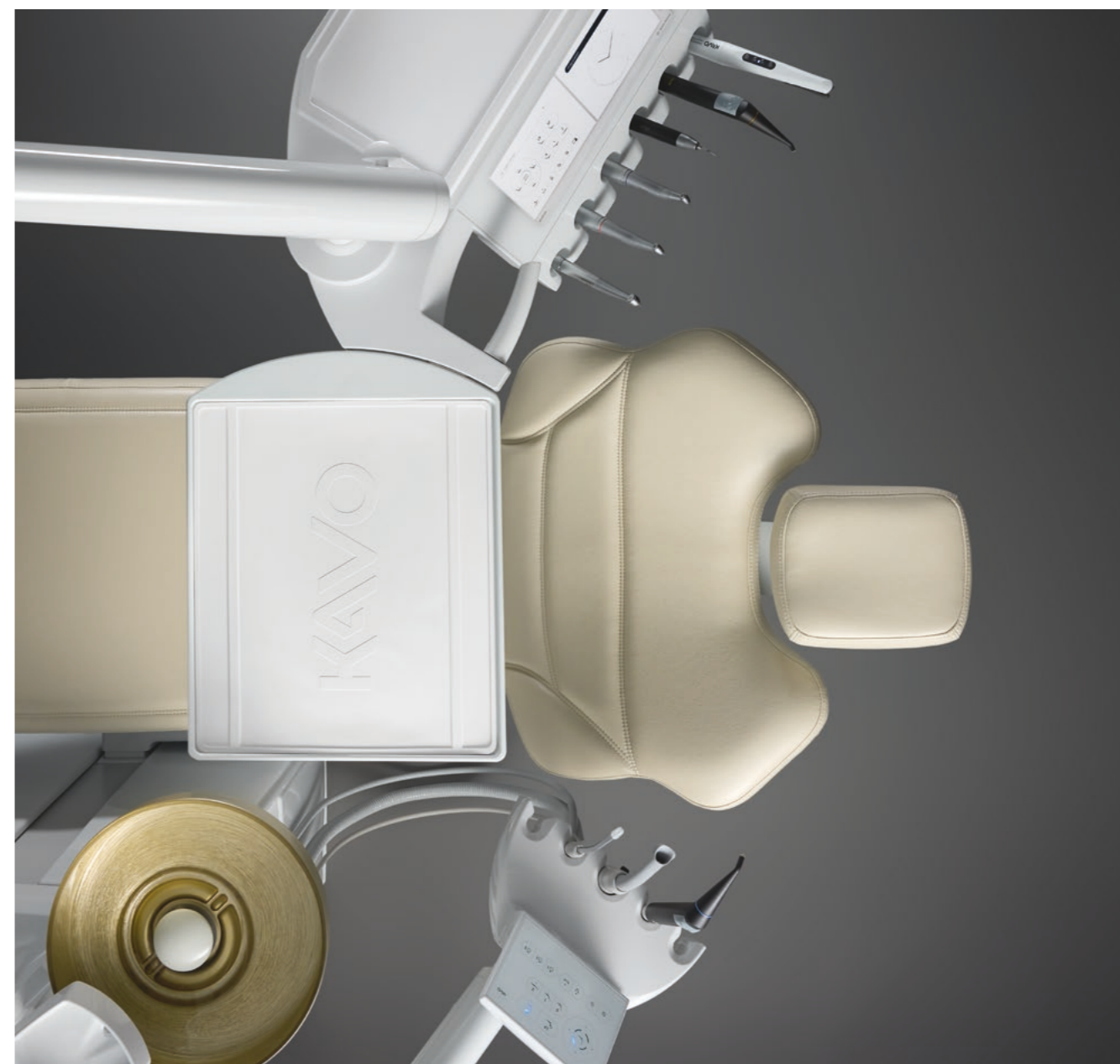

First-class legroom.

The unique suspended chair concept of the KaVo ESTETICA E70/E80 Vision gives you all the freedom you need to work in a healthy, relaxed position. You'll love the amount of free space under the patient chair, too, as you can place the foot control exactly where you want it. The concept allows for the optimal back-friendly working position – close enough to the patient and with plenty of freedom of movement.

Everything under control.

All of the key functions and integrated devices of your E70/E80 Vision can be operated with the smart, lightweight foot control. The smart right-left control is intuitive and is easy to use even when standing, so your leg muscles stay relaxed even during long treatments. The KaVo foot control is also available as a cordless version for even more choice of placement.



The right inclination.



Perfectly positioned.

Tilting patients in the Trendelenburg position enables optimum and comfortable patient inclination in every treatment position. The footrest tilts and rises automatically to match the backrest angle and prevents compression or stretching of the patient's back. The raised leg position also supports the patient's circulation.



Comfort backrest: maximum patient comfort with extra-wide shoulder support and torso length adjustment



Progress backrest: correct working posture and optimal access for the dentist



The double-jointed headrest comes in pneumatic, motorised and mechanical designs



Comfort starts from the top.

Make yourself and your patients comfortable. The smart double-jointed headrest can be precisely adjusted to individual requirements. The head tilt angle is fully adjustable and the locking positions adapted to the patient's anatomy. The motorised version of the headrest and the special comfort head cushion offer extra comfort.

The super-soft comfort head cushion moulds perfectly to the neck and provides gentle support.

The ultimate in patient comfort.

With this masterpiece from KaVo, you're perfectly prepared for every patient. The load capacity and Comfort backrest of the ESTETICA E70/E80 Vision allow the dental unit to be optimally adapted to almost any body shape and patient constitution. The Progress backrest offers you optimal access to the patient in every treatment situation. The comfort head cushion and the RELAXline soft upholstery with their soft, leather-like surface provide additional comfort, even during longer treatments. This is next-level ergonomic comfort.

Premium at its best – exclusively for the KaVo ESTETICA E80 Vision.

Workflows optimised down to the finest detail. Experience a completely new way of working. Discover the ultimate in treatment comfort for you and your patients. The outstanding features of the KaVo ESTETICA E80 Vision take treatment to the next level. See for yourself!



Practitioners and patient alike love the comfort of motorised seat elevation from KaVo

Optimal positioning for every patient

With motorised seat elevation, children and even patients with a hollow or hunched back can lie comfortably and in an ergonomically correct position. Seat elevation also offers additional lying comfort for long treatments, as you can reposition patients at intervals.

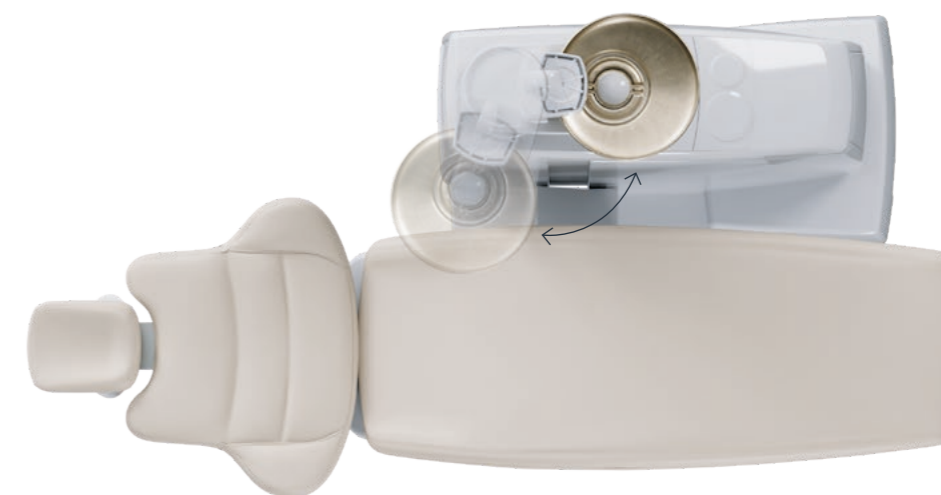

Auto-swivelling spittoon bowl

The spittoon bowl automatically swivels towards the patient when it reaches the rinsing position, then swivels back as soon as the patient returns to their original treatment position (standard with the E80 Vision, optional with the E70 Vision).









This frees up space for you to use for whatever you need it.

Everything exactly where you need it

Whether your patient is short or tall, horizontal tracking ensures that your working area – the patient's mouth – remains in the same place. Your reaching distances are always the same, even if you move the patient chair when switching between upper and lower jaw treatments.

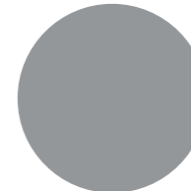
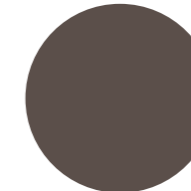
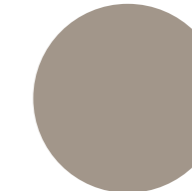

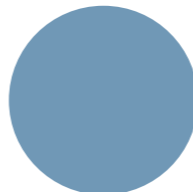
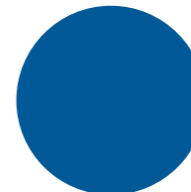
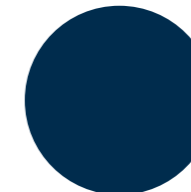
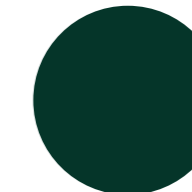
“Inspired by Nature” upholstery colours

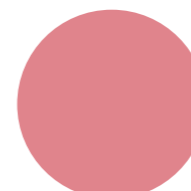
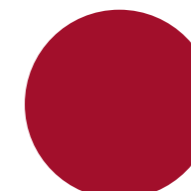
| | | | | |
|---|---|---|---|---|
|  |  |  |  |  |
| Lava S / R | Graphite S / R | Stone S / R | Coffee S / R | Sand S / R |
|  |  |  |  |  |
| Pearl S / R | Frost S / R | Ocean S | Midnight S / R | Forest S / R |
|  |  |  |  | |
| Pine S | Jade S | Rosé S | Chili S / R | |

Available as:
S – Standard
R – RELAXline

Designed for relaxation

RELAXline: designed for relaxation

The KaVo RELAXline soft upholstery combines attractive design with maximum lying comfort and to ensure relaxed positioning and a feel-good experience. The ultra-comfy memory foam moulds perfectly to the contours of the patient’s body, while the soft, leather-like surface is pleasant to the touch. High-quality, hand-stitched design seams give the RELAXline range a sleek and sporty look.



In the right light

Lighting design is often used to create beautiful effects – and the new C-curve of the ESTETICA E70/ E80 Vision is a good example. This stylish lighting element provides soft, indirect light and a relaxed spa ambience.



Standard
 Traditional upholstery with matt upper.

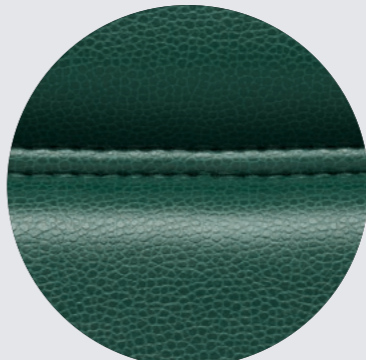

RELAXline
 Leather-like upper, memory foam with decorative seams.

Top-quality modern design: all KaVo upholstery is crafted by hand in Germany, with design studio quality. Both the RELAXline upholstery with its soft, leather-like surface and high-quality seams and the traditional upholstery with a matt finish are elegantly complemented by the “Inspired by Nature” colour collection. Whichever upholstery line you choose, the colour collection creates options for setting stylish aesthetic accents with your dental unit, in line with the latest interior trends.

Paint colours

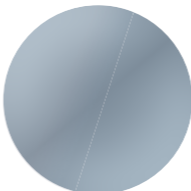
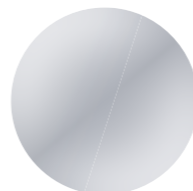
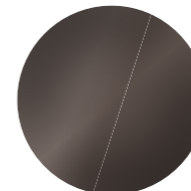
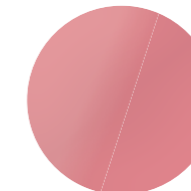
| | | | |
|---|---|---|---|
|  |  |  |  |
| Blue Silver Metallic | Silver Metallic | Coffee Metallic | Rosé Metallic |

Technology that makes assistants' work easier

Delight your team with the assistant element of your KaVo ESTETICA E70/E80 Vision. Intuitive, self-explanatory operation. Equipped with a sensitive touch panel and a clear user interface. All central patient chair and hygiene functions and treatment light functions are instantly accessible. Then there's the flexible height adjustment and large swivel range – the assistant element is an ergonomic marvel!

Perfectly suited to your specific requirements

The assistant element offers plenty of options for customising the technology to individual preferences. It's freely configurable and can be perfectly adapted to the respective requirements of your assistant, from the polymerisation handpiece to an extra saliva ejector and intraoral scanner.

Intraoral scanning – within your KaVo dental unit

Experience impression taking at record speed. With the KaVo ProXam iOS intraoral scanner, you can take highly detailed digital impressions on your ESTETICA E70/E80 Vision in the shortest possible time. Digital impressions can be displayed directly on the KaVo screen via Romexis and CONNECTbase.



For a perfect workflow, you need everything close at hand.

Everything has a designated place.

Enjoy perfect workflows. At the core of the product is the KaVo Centro carrying system, where all key devices are sensibly and ergonomically arranged in one place. This forms the fulcrum of your treatment processes, reach paths and movement sequences. The short reaching distances mean that you have everything under control at all times.

You remain completely flexible when converting and upgrading to other devices and future technologies. Devices and components can be exchanged quickly and easily using the many adapters.



Custom configuration for treatment requirements – the Centro carrying system



Intraoral X-rays always at hand

Alternatively, simply use an adapter to install a suitable small X-ray unit, such as the KaVo ProXam iX, on the light mounting rod, and you can create X-ray images optimally adapted to the radiological indication on the dental unit itself. This solution is highly precise, saves time and can be conducted without disruption to the patient.

Full automation for safe hygiene



Cleaning your KaVo ESTETICA E70/E80 Vision couldn't be easier: simply remove the main components for germ reduction. All surfaces are easy to clean, while automatic programs take care of the rinsing of instruments and the cleaning and germ reduction of the suction hoses. This guarantees thorough hygiene.

Germ reduction made easy

The hygiene centre is integrated into the unit body of the KaVo ESTETICA E70/E80 Vision. Connect up your suction hoses and instrument hoses to the centre, and it cleans them fully automatically with ease. The hygiene centre is removable and thermodisinfectable.

The power of water

Cleaning with the power of water. In the KaVo ESTETICA E70/E80 Vision, the instrument rinsing programs are combined with the automated HYDROclean program for effortless cleaning of the suction and drainage systems. This eliminates downtime and reduces maintenance costs for your dental unit.



Automatic rinsing program

Minimising risks and ensuring that your KaVo ESTETICA E70/E80 Vision remains compliant with RKI guidelines is easy with the pre-set cleaning programs. Run them at any time - in the morning, after every treatment, in the evening or weekly. The hygiene tab provides step-by-step instructions. Once you've set them up, the programs take care of rinsing and cleaning by themselves.

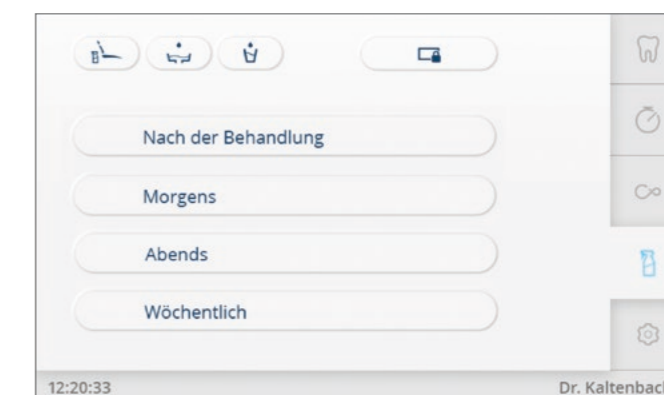

Safety, hygiene and flexibility – no exceptions, no compromises. With DVGW water block.

KaVo is setting new standards for the centrepiece of the dental unit with its next-generation water technology. The DVGW water block supplies spray and rinsing water for the instruments and the patient, and automatically dispenses the correct concentration of KaVo OXYGENAL 6. The cascade design of the water block, prevents water from the dental unit from flowing back into the drinking water system. This maintains the quality of your water supply while consistently meeting the exacting DVGW standards. The cascade path is also cleaned by flooding the collecting basin with KaVo OXYGENAL 6 concentrate. This enables the highest levels of hygiene and safety for your patients.

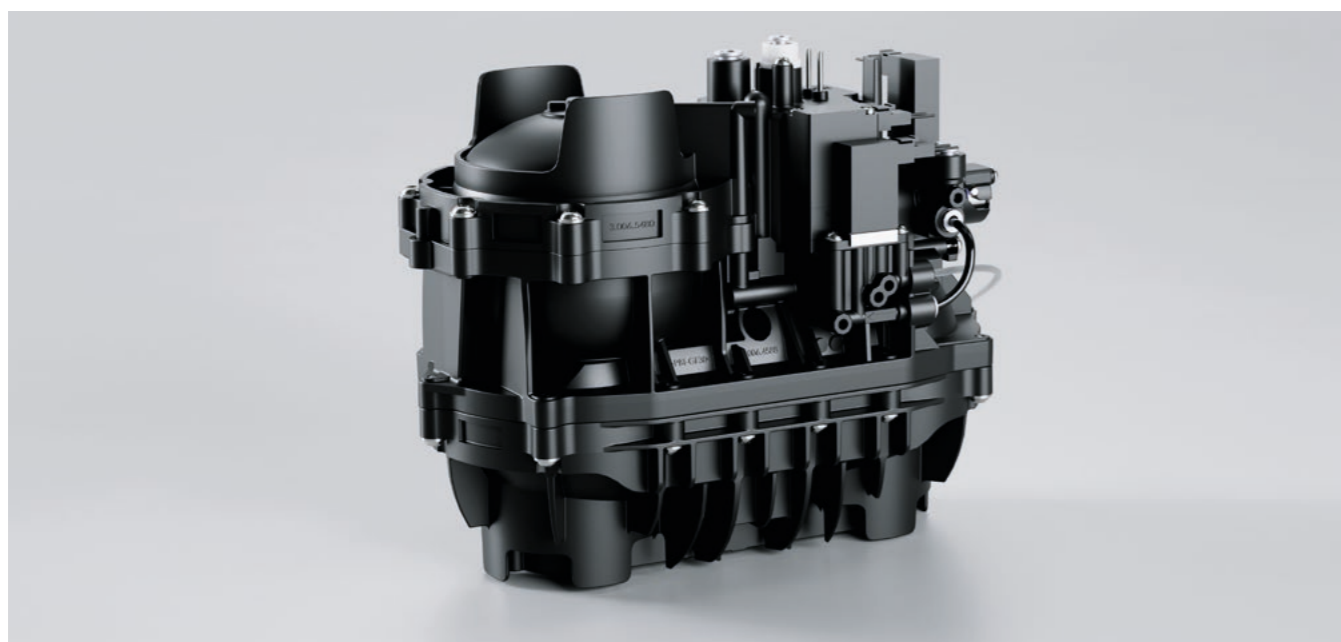

Germs don't stand a chance

Protect the lines of your KaVo ESTETICA E70/E80 Vision against contamination. Continuous germ reduction with KaVo OXYGENAL 6 ensures that no microorganisms can spread during normal practice operations. With the intensive germ reduction program ("Weekly" cleaning program), you can protect your patients against microorganisms that can form during downtimes such as weekends or holidays, and also ensure that the cooling and rinsing fluids are of impeccable quality. For safety round the clock.



KaVo has thought carefully about everywhere dental unit users will place their hands. You can simply remove contaminated parts such as handles, instrument holders and spittoon bowls for cleaning, germ reduction or sterilisation as required.

Pure satisfaction

With the DEKamat, the DEKASEPTOL bottle is integrated into the unit body for standardised effective cleaning and germ reduction of suction paths. The ready-to-use DEKASEPTOL can be applied straight into the suction hoses and systems. The special advantage of this is that the gel adheres to the critical points instead of just being rinsed through. Germ reduction of the patient's water supply is just as effortless with the OXYmat, as the OXYGENAL 6 bottle is also placed in the unit body. The correct amount of the respective cleaning agent is automatically dispensed. This does away with labour- and time-intensive manual preparation and eliminates the risk of incorrect dosing, while also preventing contact with the detergents.

Protected water supply system

KaVo instruments and motors have an anti-reflux system that prevents contaminated spray water from being sucked into the dental unit. This protects the water supply system.



Picture it: optimal patient communication.

Explain required treatment measures to your patients clearly and in detail thanks to high-resolution diagnostic images and pictures with brilliant colour reproduction.



DIAGNOcam Vision Full HD – Innovation at its best.

Imagine there was a camera that could provide you with three clinically relevant images for caries diagnosis – strikingly sharp and in less than a second. Well, now it's possible: with the DIAGNOcam Vision Full HD you can choose whether you want to take an intra-oral, transillumination or fluorescence image – or prefer to combine two or three shooting modes. The HD resolution of 1920 pixels x 1080 pixels means that all images are displayed in brilliant sharpness. The low weight and ideal balance of the camera enable ergonomic handling and fatigue-free working.

KaVo ProXam iCam – a small camera with a big impact

Use perfect images with a high depth of field and excellent colour reproduction to explain the dental situation to your patients. The easy-to-use KaVo ProXam iCam always provides you with the optimal image. The camera enables a sharp picture to be displayed at an image distance of just 9–35 mm and also has a macro mode. Image capture can be triggered by hand or with the foot control.



Show your patients

The 22" KaVo screen offers high-resolution image quality in full HD, impressive contrast values and brilliant colour reproduction. With two digital inputs, it is optimally coordinated with all the functions of imaging devices such as cameras or microscopes. For maximum hygiene, the screen has a protective glass panel, small gaps on the housing and can be adjusted with just one hand. The choice couldn't be clearer!



Your mainstay of patient communication – integrated, simple and efficient.

KaVo CONNECTbase opens up an easy new workflow in patient communication. You can use CONNECTbase to explain your patients' dental situation to them directly on the KaVo ESTETICA E70/E80 Vision, without installing any additional software. Simply connect your camera and get started right away. The images are displayed on the screen of the dental unit and can be compared with previously saved images.



Plug-and-play – streamlined workflows made easy

By using cameras directly with the KaVo dental unit, you can access your camera images in no time at all and then export them via USB.

It's just as easy to operate using the touchscreen display or the foot control on your dental unit, so you won't need to leave your workstation during treatment or interrupt your workflow unnecessarily.

Want to access additional inputs? No problem. Different HDMI sources can be displayed on the screen of your dental unit simply by switching over on the dentist element.

Make your treatments an experience

Alleviate boredom during waiting times and, if necessary, create a welcome distraction for your patients through visual experiences directly on the KaVo ESTETICA E70/E80 Vision. The great selection of media, including a customisable welcome screen and various screen savers with a large selection of photos or slideshows, will delight patients of all ages. At the same time, you can use your screen to advertise topics related to your practice or communicate relevant information.

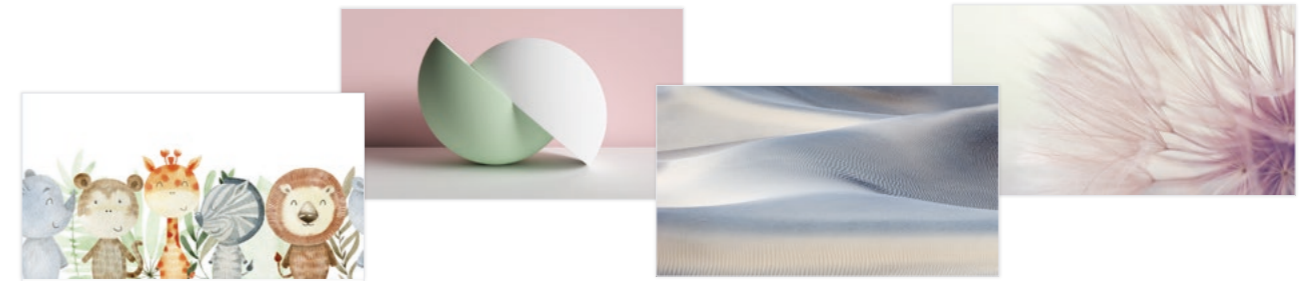

Choose from a wide variety of themes for your screen background to match the design of your practice.



KaVo **CONNECT**
link

Link up your practice management software with ease.

CONNECTlink software connects your practice management software to the KaVo dental unit, enabling quick and easy transfer of patient data and clinical images. This gives you direct access to all relevant data on the touchscreen display on the dentist element of your KaVo dental unit and allows you to add new clinical images with the KaVo cameras as usual. Thanks to CONNECTlink, these images are automatically transferred to the practice management software and assigned to the respective patient file.

The CONNECTlink software can be purchased as a separate module for your existing CONNECTbase patient communication system. To use the CONNECTlink software, you need CONNECTbase and the corresponding CONNECTlink licence on the respective KaVo dental unit.

KaVo Lumina with UX Light Technology. Enjoy the light side of dentistry.

The KaVo Lumina is setting new lighting standards in dental practices. A truly stunning piece of equipment, it takes lighting technology to a whole new level, boasts a variety of smart features and sets the gold standard in terms of user experience. The innovative UX Light technology enables perfect illumination of all levels right up to the molar area – without annoying reflections on the anterior teeth. Combined with the optimised light field, this is easy on the eyes and facilitates concentrated work. With its precise colour rendering, the natural light spectrum offers 'Made by KaVo' quality, enhancing the day-to-day work of technology enthusiasts and design aficionados alike.

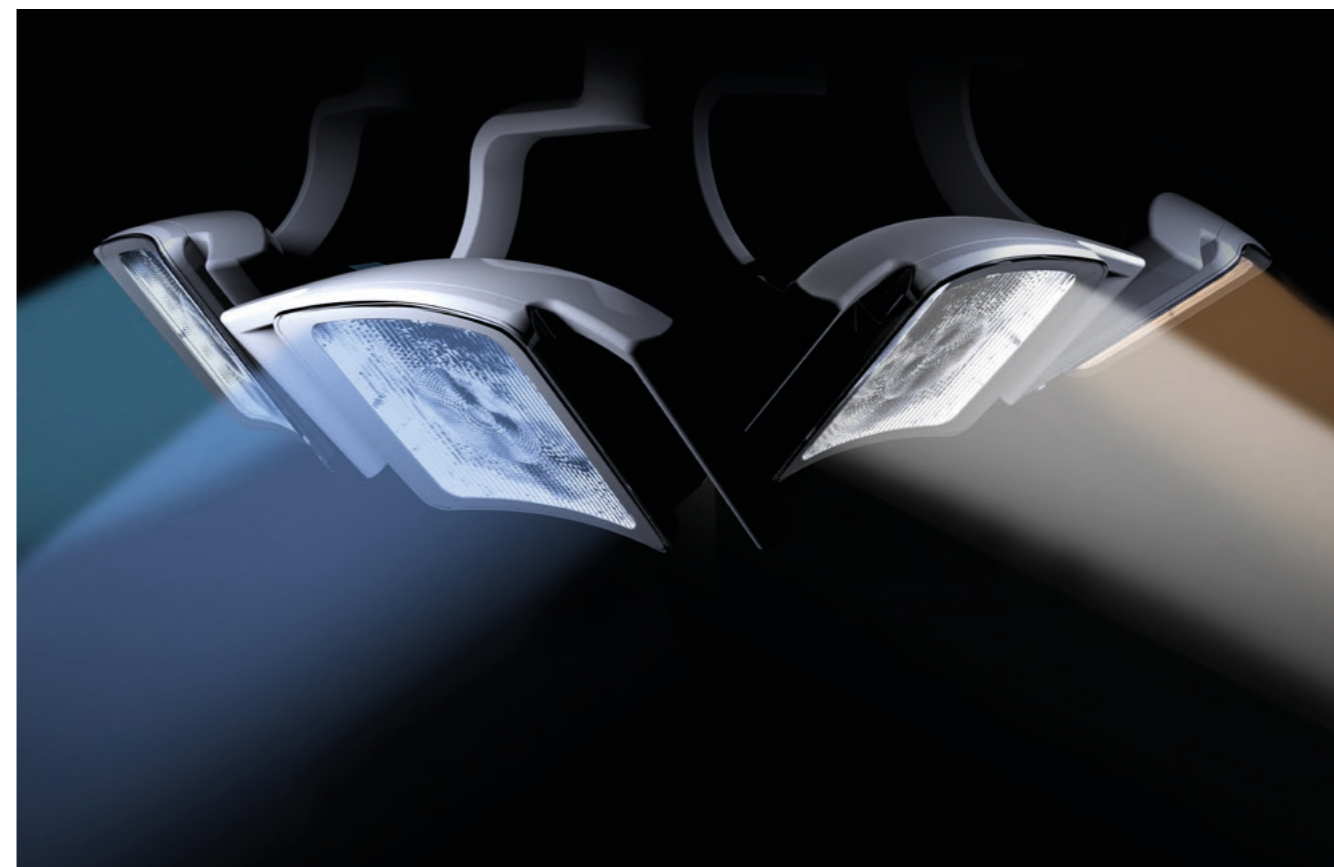

Smooth movement redefined

The combination of balanced structure and comfortable handles, inspired by Japanese chefs' knives, perfects the smooth movement and positioning of the KaVo Lumina.



COMPOshape mode

The colour spectrum of the new COMPOshape mode with its reduced proportion of blue supports aesthetic layering. So thanks to improved colour and structure reproduction, contrasts are visible without premature hardening of the composite.



UX Light Technology

The Lumina's new UX Light Technology is created by combining an innovative single-optical system with a unique collimator. It generates constant, pulse-free light of the highest quality. The natural colour spectrum created by the UX Light Technology eliminates the need to adjust the colour temperature and enables optimised illumination of the molars without annoying reflections on the anterior teeth. It also forms a new, ergonomic light field.



Discover the different Lumina colour modes

SPAlight mode

The SPAlight provides a play of colours consisting of shades of blue and green that have a proven calming effect, according to cutting-edge colour psychology. This means it can be used to create a relaxing atmosphere and a spa-like vibe before and between treatments.

Perfect ergonomics and comfort: the KaVo PHYSIO Evo



Awarded the seal of approval of the "Healthy Back Campaign" (Aktion gesunder Rücken, AGR)



As a dentist, maintaining an ergonomically healthy and comfortable posture in every treatment situation is crucial. And nothing affects your posture more than the operator stool you sit on every day. The KaVo PHYSIO Evo and Evo F are precisely tailored to the needs and workflows of dentists and their assistants.



Ergonomic comfort is all about the detail.

With separate adjustment functions, the seat and backrest can be adjusted to your anatomical requirements and your personal treatment style. The back and seat upholstery of the KaVo PHYSIO Evo are ergonomically moulded. The centred elevation in the seat upholstery provides a stable sitting position and prevents slipping even during quick, short rolling movements. The rounded thigh support offers plenty of freedom of movement. The spring-assisted backrest provides constant support for your back muscles, especially in the lumbar region, thus protecting them over the long term.

Equipment options

| | E80 Vision | E70 Vision | | E80 Vision | E70 Vision |
|---|------------|------------|--|------------|------------|
| Patient chair | | | Assistant element | | |
| Soft upholstery | ● | ● | Touch panel | ● | ● |
| RELAXline soft upholstery | ○ | ○ | Spray mist suction | ● | ● |
| Motorised horizontal tracking | - | - | Saliva ejector | ● | ● |
| Motorised seat elevation | - | - | 2. Saliva ejector | ○ | ○ |
| Backrest | | | Triple function handpiece | ○ | ○ |
| Comfort | x | x | Minilight triple function handpiece | ○ | ○ |
| Progress | x | x | Satelec MiniLED polymerisation handpiece | ○ | ○ |
| Headrest | | | Tray holder for tablet holder | ○ | ○ |
| Double-jointed, mechanical | - | ● | Height-adjustable arm | ● | ● |
| Double-jointed, pneumatic | ● | ○ | Detachable instrument holder | ● | ● |
| SOMATIC, electromotive | ○ | ○ | Unit body | | |
| Comfort head cushion | ○ | ○ | Glass spittoon bowl | x | x |
| Armrest | | | Porcelain spittoon bowl | x | x |
| Left | ○ | ○ | "Elegance" spittoon bowl | ○ | ○ |
| Left and right | ○ | ○ | Spittoon bowl, motorised, swivelling | ● | ○ |
| | | | Hygiene centre | ● | ● |
| | | | Constant germ reduction | ● | ● |
| | | | Intensive germ reduction | ● | ● |
| | | | HYDROclean (suction rinsing system) | ● | ● |
| | | | DEKAmat™ and OXYmat | ● | ● |
| | | | Warm water boiler | ● | ● |
| | | | VACUstopp | ● | ● |
| | | | Wireless foot control | ○ | ○ |
| Dentist element | | | Supply system | | |
| Touch display | ● ● | ● ● ● | DVGW water block | ● | ● |
| Turbine hose | ○ ○ | ○ ○ ○ | Connection to external devices | ○ | ○ |
| INTRA LUX Motor KL 703 LED™ | ○ ○ | ○ ○ ○ | AQUAmat | ● | ● |
| Endofunction | ○ ○ | ○ ○ ○ | Disposal system | | |
| COMFORTbase | ○ ○ | ○ ○ ○ | External dust extraction unit | ● | ● |
| Triple function handpiece | - - | x x x | DÜRR amalgam separator | ○ | ○ |
| Minilight triple function handpiece | - - | x x x | DÜRR automatic separator | ○ | ○ |
| Multifunction handpiece | ● ● | ○ ○ ○ | Treatment light: | | |
| KaVo eSCALER ultrasonic scaler | ○ ○ | ○ ○ ○ | KaVo Lumina | ○ | ○ |
| SONICflex™ sonic scaler | ○ ○ | ○ ○ ○ | Light mounting rod | ○ | ○ |
| Physiological saline solution | ○ ○ | ○ ○ ○ | Adapter for light mounting rod | ○ | ○ |
| S600 LED surgical motor | ○ ○ | ○ ○ ○ | Patient communication | | |
| Spray warming for instruments | ● ● | ● ● ● | KaVo Screen | ○ | ○ |
| Anti-reflux system for instruments | ● ● | ● ● ● | CONNECTbase | ○ | ○ |
| Detachable instrument holder | ● ● | ● ● ● | CONEXIO™ | ○ | ○ |
| USB interface | ● ● | ○ ○ ○ | KaVo ProXam iCam | ○ | ○ |
| Pneumatic brakes for arm system | ○ ○ | ○ ○ ○ | KaVo DIAGNOcam Vision Full HD™ | ○ | ○ |
| Tablet holder for two norm trays | ● ● | ● ● ● | | | |
| Adjustable service table for two norm trays | ● - | ● - - | | | |
| Service table 1658 | - ● | - - ● | | | |

● Standard equipment ○ Optional equipment x Must be selected - Not available

Dental Excellence in every area

What our brand represents

KaVo is a long-established, dependable manufacturer, and always will be. We and our products have stood for the highest quality and reliability for over 100 years, so our customers can concentrate on what's important.

KaVo is adept and uncompromising when it comes to combining essential requirements, ergonomics, the highest standards of hygiene and design to create the best overall package. Thanks to our perfect interplay of dynamism and expertise, we're always at the cutting edge.



KaVo dental units -
an investment in your health



KaVo instruments -
feel the difference.



KaVo Imaging -
see more, plan better



Dental training -
effective learning

The products, equipment and services shown and described in this brochure are not available in every country. The information given here reflects the knowledge available at the time of printing. KaVo Dental GmbH accepts no liability for deviations in colour and form in the illustrations, or any errors or misprints, and reserves the right to make changes to the brochures at any time.

KaVo, ESTETICA, uniQa, amiQa, Primus and Lumina are registered trademarks of KaVo Dental GmbH.